

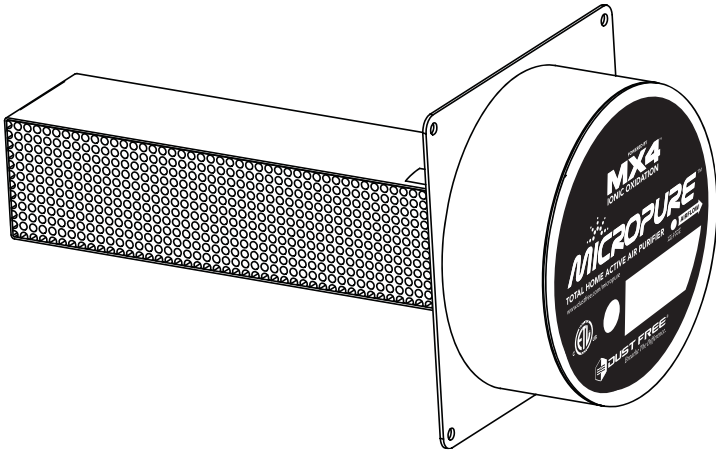

MICROPURE[®]

TOTAL HOME ACTIVE AIR PURIFIER



OWNER'S MANUAL

	24V	120V/230V
MicroPure [®] 5" with MX4 [™]	#14015	#14003
MicroPure [®] 9" with MX4 [™]	#14013	#14004
MicroPure [®] 9" with MX4 [™] Lite	#14016	#14001
MicroPure [®] 14" with MX4 [™]	#14017	#14005
MicroPure [®] 14" with MX4 [™] Lite	#14014	#14002

Read manual carefully for proper procedures and operation.

CONGRATULATIONS . . .

on your purchase of the MicroPure® Total Home Active Air Purifier by Dust Free®. This unit is designed to be installed into an existing HVAC system and provide virtually maintenance free air purification. Please read and follow all service procedures outlined in this manual.

Please record the name and phone of your Dust Free® dealer.

Name _____

Phone _____

Please record the serial number of your MicroPure® system.

Serial # _____

CONTENTS

Product Contents	3
Installation Hardware	3
Replacement Parts	3
Specifications	4
About MicroPure®	4
Recommended Installation Tools	5
Installation Requirements	5
Metal Ductwork Installation	6
Fiberglass Ductwork Installation	8
Maintenance/UV Lamp Indicator	10
Disposal of MX4™ core	10
Changing MX4™ core	11
Warranty	12

PRODUCT CONTENTS

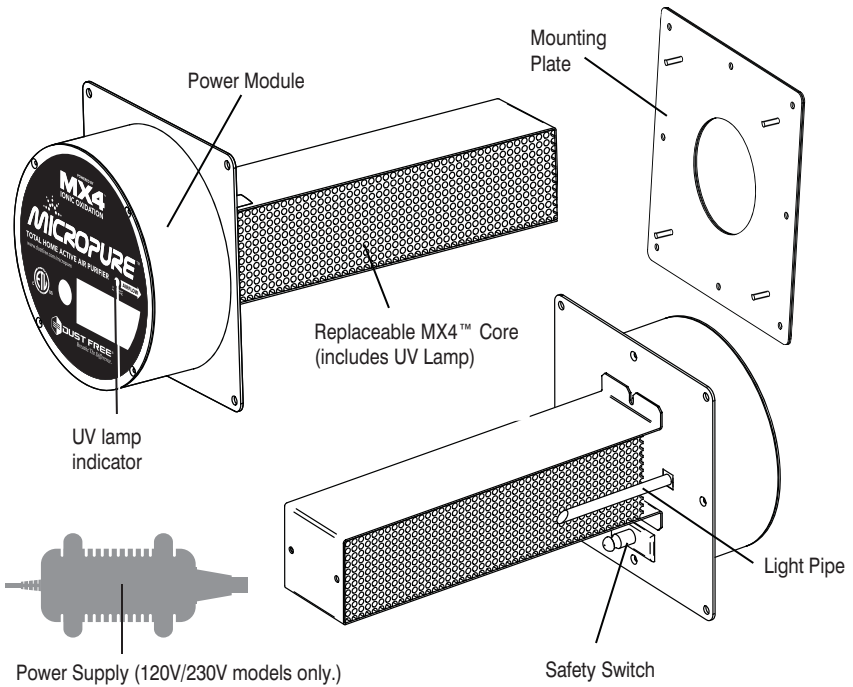

INSTALLATION HARDWARE

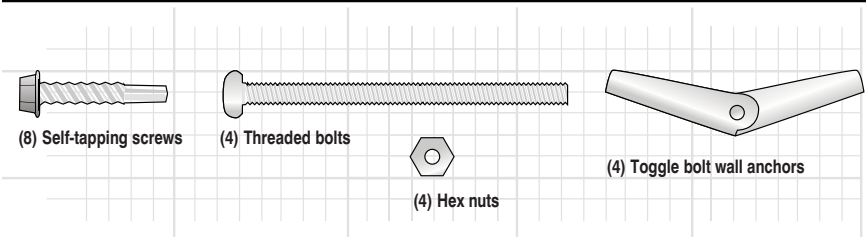

REPLACEMENT PARTS

MX4™ Core (Includes UV Lamp)

UV Lamp

Mounting Plate

Power Module (Includes power supply, safety switch, and light pipe.)

Power Cord (For 24V and 230V operation)

120V Power Supply

Dimensions:

5" Model: 6"H x 6"W x 7"L

9" Model: 6"H x 6"W x 11"L

14" Model: 6"H x 6"W x 16.75"L

Mounting Plate: 8"H x 8"W

Electrical:

24V 50/60Hz or 120V/230V

50/60Hz (auto-sensing),
depending on model.**Output:**

5" and 9" Models: 13.3 Watts.

14" Model: 19.2 Watts.

Weight:

Approx. 2.6lbs - 3lbs.

IMPORTANT:

The device must be installed in compliance with all national and local electrical and mechanical codes. Failure to do so will void ETL safety listing and Dust Free® warranty.

Specifications subject to change without notice.

ABOUT MicroPure®

The MicroPure® Total Home Active Air Purifier is a new generation HVAC air system designed to reduce odors, smoke, germs, and a broad spectrum of indoor air contaminants.

The MicroPure® system is easily mounted into HVAC system air ducts where many air quality problems can start. Using a unique technology, The MicroPure® system uses UV light energy to illuminate a quad-metallic core to produce ionic oxidizers that seek out and attack indoor pollutants. These ionic "air scrubbers" clean the air AND surfaces where ever the air goes.



WARNING! UV Light in operation. Disconnect unit from power supply before servicing. Failure to follow warnings may result in severe eye damage.



To reduce the risk of electric shock, this equipment may have a grounding type plug that has a third (grounding) pin. This plug will only fit into a grounding type power outlet. If the plug does not fit into the outlet, contact qualified personnel to install the proper outlet. Do not alter the plug in any way .



Location for Protective Earth Line.

RECOMMENDED INSTALLATION TOOLS

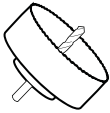

3 1/2" Hole Saw
for metal
(recommended)

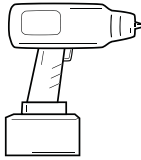

Drill/Power Driver



Phillips Screwdriver



3/8" Drill Bit
(if installing into fiberglass
ducting with toggle bolts)

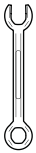

11/32" Open-End Wrench



1/4" Nut Driver Bit



Utility Knife



Tin Snips
(for metal ductwork)

You may also need:

INSTALLATION REQUIREMENTS

1. Unit should be installed after the air handler in the HVAC system.
2. The duct work around the installation area should be clean and dry to insure proper adhesion of the gasket materials and any tape used.
3. An approximate 3.5" (8.89 cm) opening will need to be cut into the existing duct work to install the unit properly.

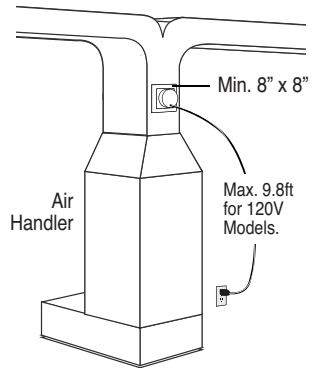

Electrical Requirements (120V only)

For 120V operation use the 120V power supply and cord. Be sure to locate the unit within 9.8ft of a standard 120V grounded outlet. Long term use of an extension cord is not recommended due to safety considerations.

Hardwiring Requirements (24V and 230V Operation)

For 24V models: Connect black and white wires to a dedicated 40Va transformer. (Not Provided.)

For 230V models: Connect black and white wires to proper power. Connect green wire to ground.



- **Electrical wiring of the unit to the HVAC system should be done by a licensed HVAC installer or electrical contractor.**

METAL DUCTWORK INSTALLATION

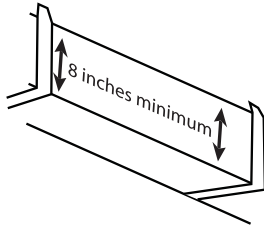

1. Locate suitable area of duct for installation. Be sure to locate near proper power.

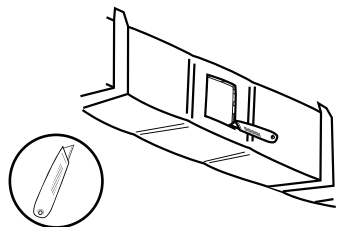

2. Cut away insulation to expose metal duct (if needed).

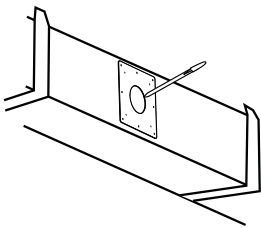

3. Mark location for 3.5" opening using either the mounting plate or included template.

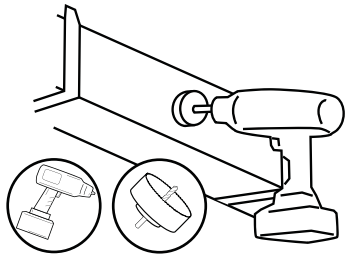

4. Cut hole in duct using 3.5" hole saw.

ALTERNATIVE CUTTING METHOD

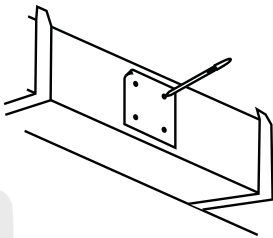

a. Using template, mark 4 holes on duct.

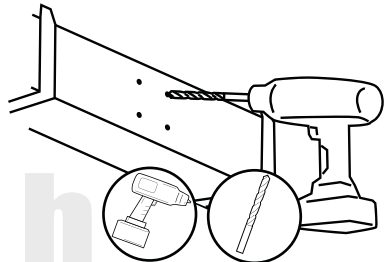

b. Drill 4 holes where marked.

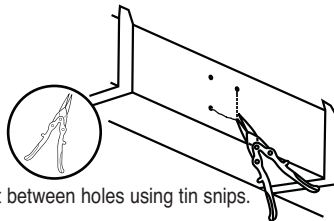

c. Cut between holes using tin snips.

METAL DUCTWORK INSTALLATION (CONTINUED)

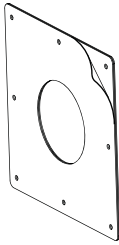

5. Remove backing from mounting plate adhesive gasket.

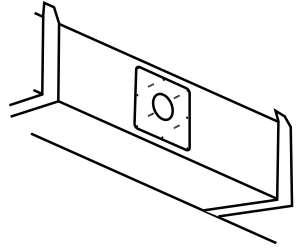

6. Center openings and press mounting plate onto duct. The adhesive gasket will hold the mounting plate in place.

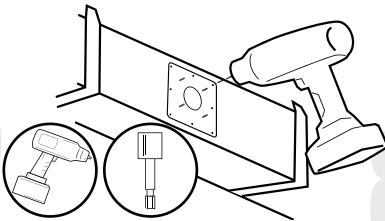

7. Secure the mounting plate using (8) self-tapping screws.

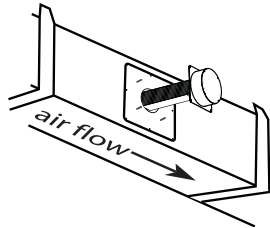

8. Insert unit into opening. Be sure the air will pass through the MX4™ core as indicated on the label.

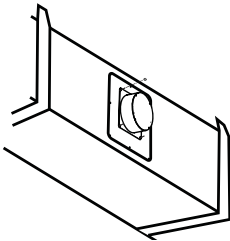

9. Secure the unit to the mounting plate with (4) hex nuts.

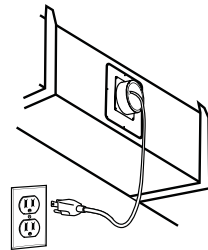

10. Plug unit into working power receptacle or hardwire to proper power.



Hard wiring unit into HVAC system should be done by a licensed HVAC installer or electrical contractor.

FIBERGLASS DUCTWORK INSTALLATION

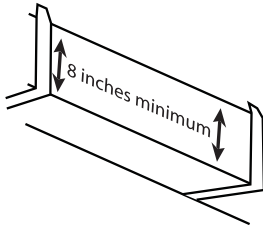

1. Locate suitable area of duct for installation. Be sure to locate near proper power.

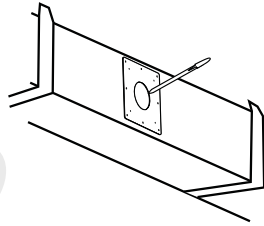

2. Mark location for 3.5" opening using either the mounting plate or included template. Also mark the locations of 4 screw holes in corners (see template).

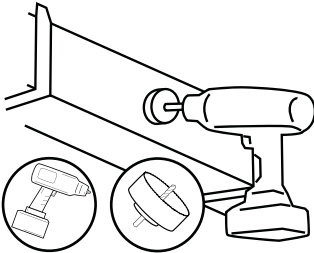

3. Cut hole in duct using 3.5" hole saw.

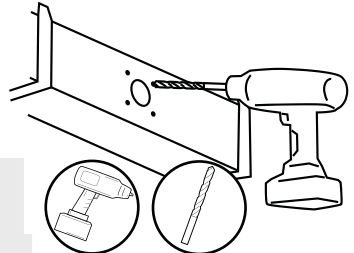

4. Drill 4 holes (at corner screw locations) using a 3/8" drill bit.

ALTERNATIVE CUTTING METHOD

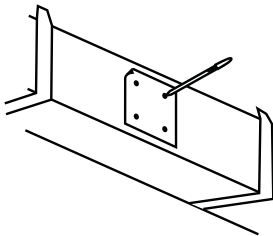

- a. Using template, mark 4 holes on duct.

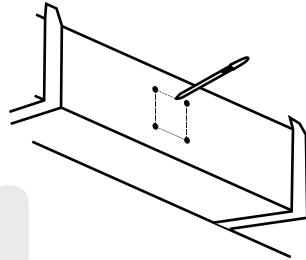

- b. Draw a line between each corner mark.

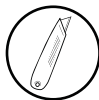

- c. Cut between holes using a utility knife. Continue with #4 (above)

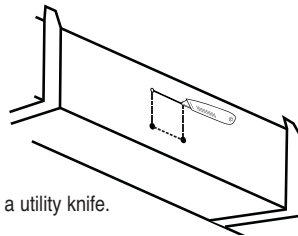

FIBERGLASS DUCTWORK INSTALLATION (CONTINUED)

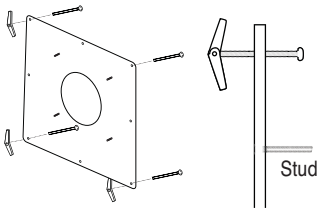

5. Insert (4) 2" Threaded bolts into screw holes at corners of mounting plate. Attach (4) toggle bolt anchors to ends of threaded bolts.

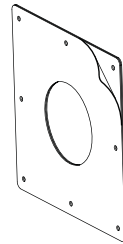

6. Remove backing from mounting plate adhesive gasket.

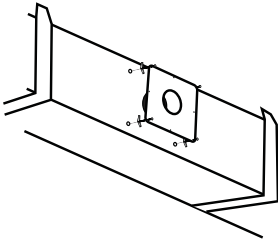

7. Insert (4) toggle bolts into 3/8" holes in duct. Be sure toggle anchors open after inserting.

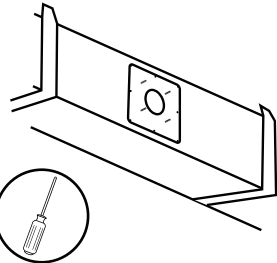

8. Center large opening in mounting plate over 3.5" opening in duct and press plate to duct. The adhesive gasket will hold the mounting plate into place. Tighten toggle bolts - DO NOT OVERTIGHTEN.

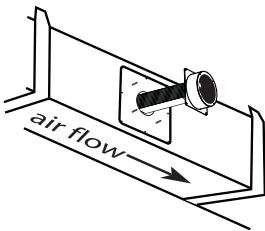

9. Insert unit into opening. Be sure the air will pass through the MX4™ core.

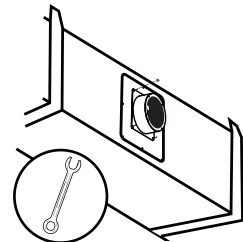

10. Secure the unit to the mounting plate with (4) hex nuts.

11

11. Plug unit into working power receptacle or hardwire to proper power.



Hard wiring unit into HVAC system should be done by a licensed HVAC installer or electrical contractor.

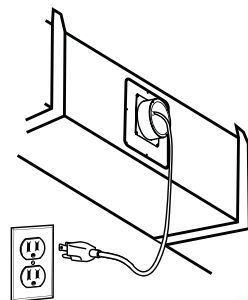

MAINTENANCE/UV LAMP INDICATOR

For optimal performance, replace the MX4™ core every 4 years and the UV lamp every 2 years, even if the UV lamp appears to be operating normally.

The UV lamp operation indicator on the face of the unit will glow when the UV lamp is in use. If the indicator does not glow and the unit has power, the MX4™ core should be replaced.

UV lamp operation indicator

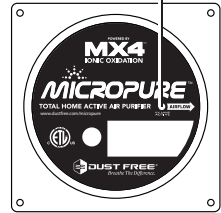

DISPOSAL OF THE MX4™ CORE AND UV LAMP

Dispose of spent MX4™ core and UV lamp at your local recycling center. You may also send your spent MX4™ core and UV lamp, in the same container you received your replacement, to :

Dust Free® MicroPure® Reclamation
1112 Industrial Drive
Royse City, TX 75189



CHANGING THE MX4™ CORE



WARNING! UV Light in operation. Disconnect unit from power supply before servicing. Failure to follow warnings may result in severe eye damage.

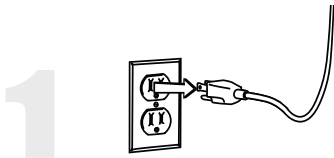

1. Unplug unit. If the unit is hard wired, be sure the power to the unit is off.

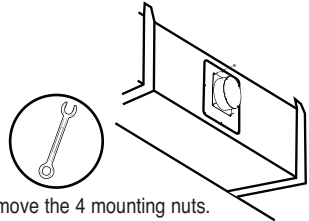

2. Remove the 4 mounting nuts.

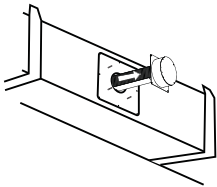

3. Remove the unit from the mounting plate.

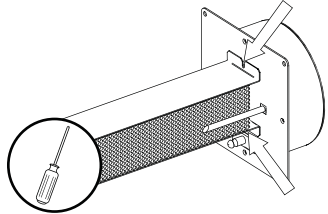

4. Remove the 2 screws holding the MX4™ core.

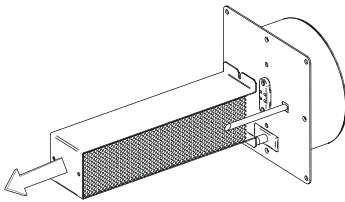

5. Separate the used core from the base unit and dispose of properly.

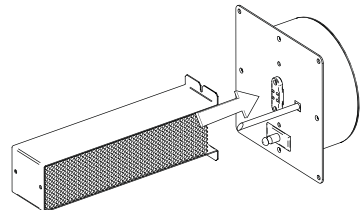

6. Plug the new MX4™ core into the base unit.

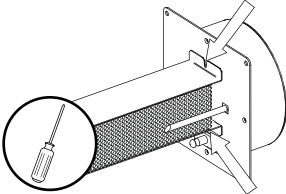

7. Secure with 2 screws.

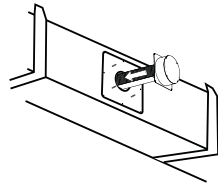

8. Insert the unit into the mounting plate.

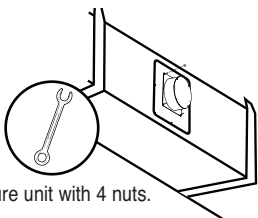

9. Secure unit with 4 nuts.

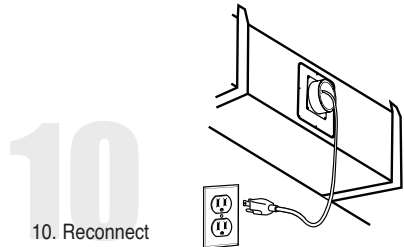

10. Reconnect power supply.

LIMITED WARRANTY

Dust Free®, LP (Dust Free) warrants to the original purchaser that the MicroPure® Total Home Active Air Purifier (other than the MX4™ core and the UV Lamp) shall be free from defect in material and workmanship under normal use and service, for a period of five (5) years from the date of original purchase. Dust Free warrants to the original purchaser that the MX4™ core shall be free from defect in material and workmanship under normal use and service, for a period of four (4) years from the date of original purchase. Dust Free warrants to the original purchaser that the UV lamp shall be free from defect in material and workmanship under normal use and service, for a period of two (2) year from the date of original purchase. Dust Free's obligation under this warranty shall be limited to the repair or replacement of those goods which prove defective, provided that such products are installed, maintained, and operated for the purpose and in the manner intended and for which Dust Free instructs or recommends. Neither Dust Free nor its dealers shall be liable for any special or consequential damages directly or indirectly arising from the design, construction, installation, servicing, or operation of the goods. SOME STATES DO NOT ALLOW THE EXCLUSION OR LIMITATION OF INCIDENTAL OR CONSEQUENTIAL DAMAGES, SO THE ABOVE EXCLUSION MAY NOT APPLY TO YOU. THIS IS DUST FREE'S SOLE WARRANTY AND THERE ARE NO WARRANTIES THAT EXTEND BEYOND THE DESCRIPTION ON THE FACE HEREOF. NEITHER DUST FREES NOR ITS DEALERS MAKE ANY OTHER WARRANTY OF ANY KIND, EXPRESS OR IMPLIED. ALL IMPLIED WARRANTIES OF MERCHANTABILITY AND FITNESS FOR A PARTICULAR PURPOSE WHICH EXCEED DUST FREES' AFFORESTATED OBLIGATIONS ARE HEREBY DISCLAIMED AND EXCLUDED FROM THIS WARRANTY. SOME STATES DO NOT ALLOW LIMITATIONS ON HOW LONG AN IMPLIED WARRANTY LASTS, SO THE ABOVE LIMITATION MAY NOT APPLY TO YOU. THIS WARRANTY GIVES YOU SPECIFIC LEGAL RIGHTS, AND YOU MAY ALSO HAVE OTHER RIGHTS WHICH VARY FROM STATE TO STATE. DUST FREE'S AND ITS DEALER'S LIABILITY UNDER THIS WARRANTY SHALL IN NO EVENT EXCEED THE COST OF THE GOODS SOLD UNDER THE CONTRACT OF SALE.

Dust Free neither assumes, nor authorizes any person to assume for it, any obligation in connection with the goods. This warranty shall not apply to any goods: (a) which have been subjected to misuse, tampering, negligence, or accidents; (b) the serial numbers of which have been altered, defaced, or removed; or (c) which have been used in a manner contrary to Dust Free's instructions or recommendations. This warranty may not be assigned or transferred. If any portion of this limited warranty is held illegal or unenforceable by reason of any law, such partial illegality or unenforceability shall not affect the enforceability of the remainder of this limited warranty.

For Warranty Claims:

By Telephone: Call Dust Free® at 1-972-635-2323, and ask to speak with a Customer Service Representative regarding a potential Warranty Claim. The Customer Service Representative will provide further instructions.

By Website: Visit Dust Free's website at www.dustfree.com and click on the "Contact" link to report a potential Warranty Claim. A Customer Service Representative will reply by email and will provide further instructions.



Dust Free®, LP, PO Box 519, Royse City, TX 75189. Please do not mail Warranty Claim requests or your product to this address. Warranty Claim requests are only accepted by telephone and through the website.