

MODEL 311AAV and 312AAV DOWNFLOW/HORIZONTAL/ UPFLOW GAS FURNACE

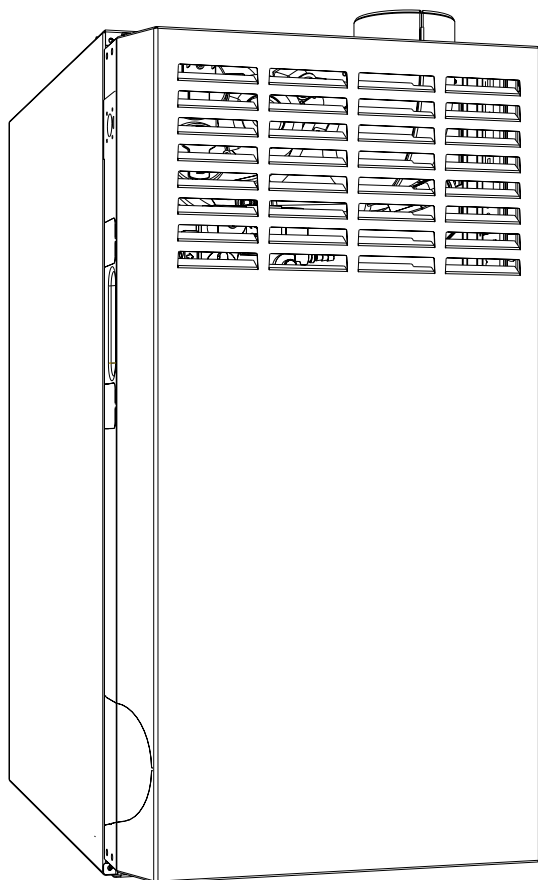

Multipoise

NOTE TO INSTALLER:
This manual must be left with the
equipment user.

⚠ WARNING: If the information in this manual is not followed exactly, a fire or explosion may result causing property damage, personal injury or loss of life.

- Do not store or use gasoline or other flammable vapors and liquids in the vicinity of this or any other appliance.
- **WHAT TO DO IF YOU SMELL GAS:**
 - Do not try to light any appliance.
 - Do not touch any electrical switch; do not use any phone in your building.
 - Immediately call your gas supplier from a neighbor's phone. Follow the gas supplier's instructions.
 - If you cannot reach your gas supplier, call the fire department.
- Installation and service must be performed by a qualified installer, service agency or the gas supplier.

Do not use this furnace if any part has been under water. Immediately call a qualified service technician to inspect the furnace and to replace any part of the control system and gas control which has been under water.

WELCOME TO TODAY'S GENERATION OF COMFORT

Congratulations! Your new, higher efficiency gas furnace is a sound investment which will reward you and your family with years of warm memories winter after winter.

Not only is your new furnace energy efficient, it is also extremely reliable. Spend just a few minutes with this booklet to learn about the operation of your new furnace—and the small amount of maintenance it takes to keep it operating at peak efficiency. Years went into the development of your new furnace. Take a little time now to assure its most efficient operation for years to come.

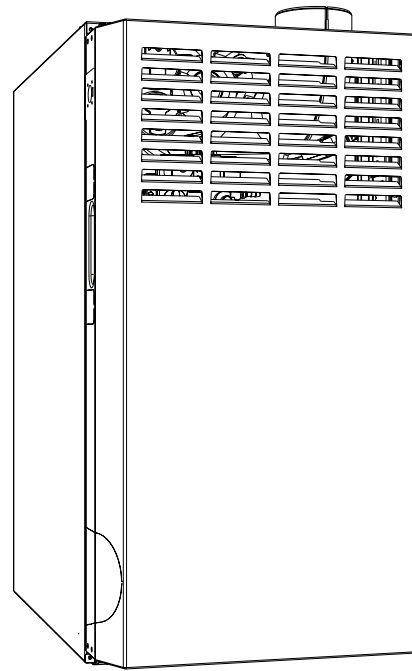

MODEL 311AAV and 312AAV

(Furnace shown in upflow position; may be used in downflow or horizontal positions also)

1

FURNACE COMPONENTS

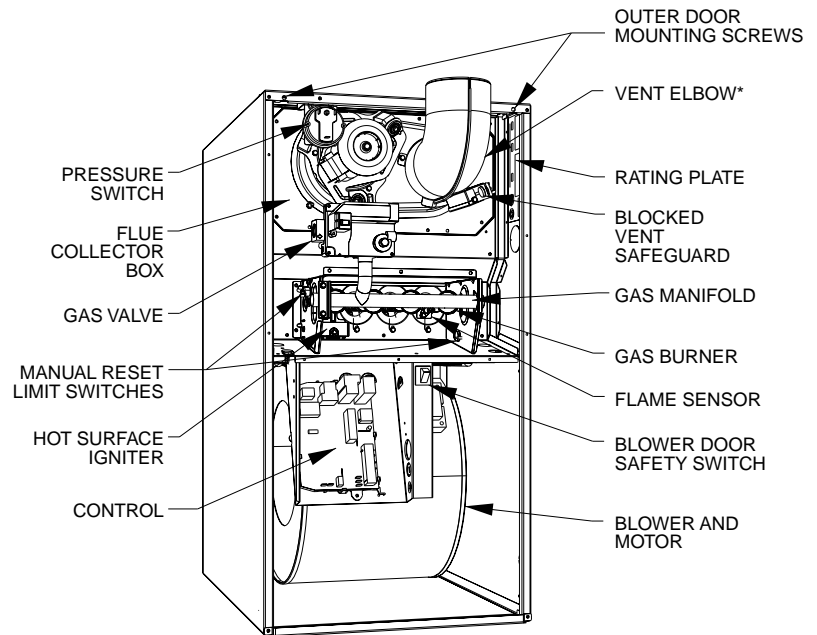

*Elbow may be turned to a different position, depending on type of installation

2

IMPORTANT FACTS

Your furnace must have adequate air-flow for efficient combustion and safe ventilation. Do not enclose it in an airtight room or “seal” it behind solid doors. To minimize the possibility of serious personal injury, fire, damage to your furnace, or improper operation; **carefully follow these safety rules:**

- Keep the area around your furnace free of combustible materials, gasoline, and other flammable liquids and vapors.

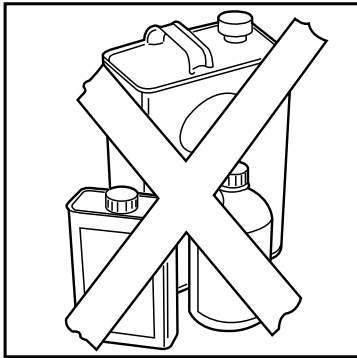

3

- Do not cover the furnace, store trash or debris near it, or in any way block the flow of fresh air to the unit.
 - Combustion air must be clean and uncontaminated with chlorine or fluorine. These compounds are present in many products around the home, such as: water softener salts, laundry bleaches, detergents, adhesives, paints, varnishes, paint strippers, waxes, and plastics.
- During remodeling be sure the combustion air is fresh and uncontaminated. If these compounds are burned in your furnace, the heat exchangers and metal vent system may deteriorate.
- A furnace installed in the attic or other insulated space must be kept free and clear of the insulating material. Examine the furnace area when installing the furnace or adding more insulation. Some materials may be combustible.

NOTE: Do not use this furnace if any part has been under water. Immediately call a qualified service technician to inspect the furnace and to replace any part of the control system and any gas control which has been under water.

NOTE: The qualified installer or agency must use only factory-authorized re-placement parts, kits, and accessories when modifying or repairing this product.

This furnace contains safety devices which must be manually reset. If the furnace is left unattended for an extended period of time, have it checked periodically for proper operation. This precaution will prevent problems associated with no heat, such as frozen water pipes, etc. See “Before You Request a Service Call” section in this manual.

SAFETY CONSIDERATIONS

Installing and servicing heating equipment can be hazardous due to gas and electrical components. Only trained and qualified personnel should install, repair, or service heating equipment.

Untrained personnel can perform basic maintenance functions such as cleaning and replacing air filters. All other operations must be performed by trained service personnel. Observe safety precautions in this manual, on tags, and on labels attached to the furnace and other safety precautions that may apply.

Recognize safety information: This is the safety-alert symbol . When you see this symbol on the furnace and in instructions or manuals, be alert to the potential for personal injury.

Understand the signal words—DANGER, WARNING, and CAUTION. These words are used with the safety-alert symbol. DANGER identifies the most serious hazards which **will** result in severe personal injury or death. WARNING signifies hazards which **could** result in personal injury or death. CAUTION is used to identify unsafe practices which **would** result in minor personal injury or product and property damage. NOTE is used to highlight suggestions which will result in enhanced installation, reliability or operation.

STARTING YOUR FURNACE

Your furnace uses an automatic hot surface ignition system to light the burners each time the thermostat signals the furnace to start. **Follow these important safeguards:**

- Never attempt to manually light the

burners with a match or other source of flame.

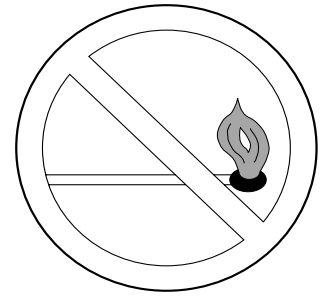

4

- Read and follow the operating instructions on the furnace, especially the item that reads as follows:

“Wait 5 minutes to clear out any gas. Then smell for gas, including near the floor. If you smell gas, **STOP!** Follow “B” in the safety information above on this label. If you don’t smell gas, go to the next step.”

- If a suspected malfunction occurs with your gas control system, such as the burners do not light when they should, refer to the shutdown procedures on the furnace, or in the next section, to turn off your system, then call your dealer as soon as possible.

WARNING

Should overheating occur, or the gas valve fail to shut off the gas supply, turn off the manual gas valve (See Fig. 6) to the furnace BEFORE turning off the electrical supply. A failure to follow this warning could result in a fire or explosion, and personal injury or death.

- **CHECK AIR FILTER:** Before attempting to start your furnace, be sure the filter is clean and in place. (See the maintenance section of this manual.) Then proceed as follows:

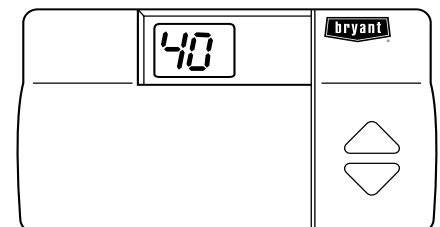

5

STEPS FOR STARTING YOUR FURNACE

1. Set your room thermostat to the lowest temperature setting. (See Fig. 5.)
2. Close the external manual gas valve. (See Fig. 6.)
3. Turn OFF the electrical supply to your furnace. (See Fig. 7.)

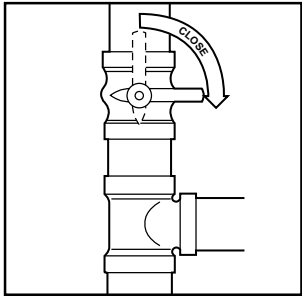

6

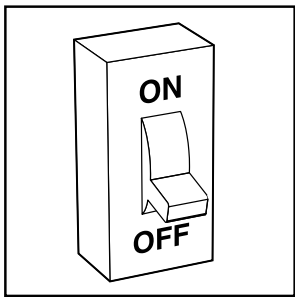

7

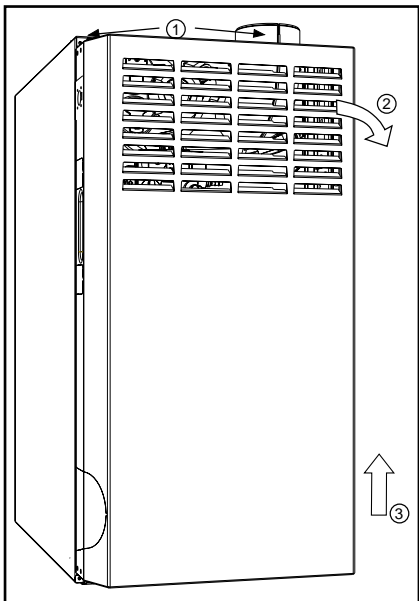

8

4. Remove the outer door by removing two screws. (See Fig. 8.)
5. The gas valve will have a control

switch to turn off and on. Turn the control switch on the gas valve to the OFF position and wait 5 minutes. (See Fig. 9.)

6. After waiting 5 minutes, turn the control switch on the gas valve to the ON position. (See Fig. 10.)
7. Replace the outer door using two screws. (See Fig. 11.)
8. Turn ON the electrical supply to the furnace. (See Fig. 12.)
9. Open the external manual gas valve. (See Fig. 13.)
10. Set the room thermostat to a temperature slightly above the room temperature. This will automatically signal the furnace to start. The inducer motor will start, and the hot surface igniter will energize. When hot, the igniter will have an orange glow.

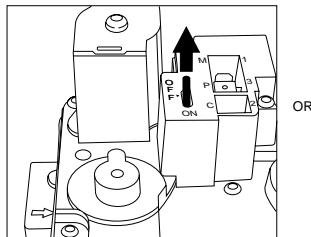

9

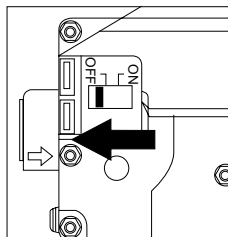

10

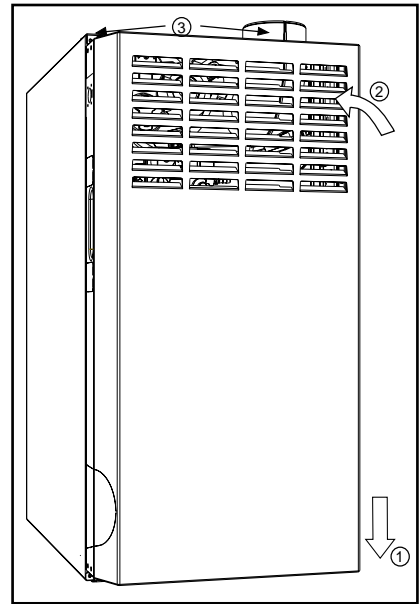
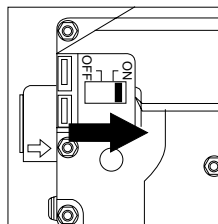
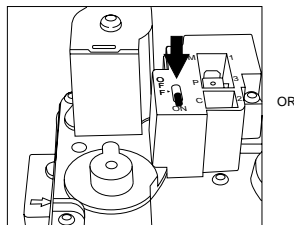

11

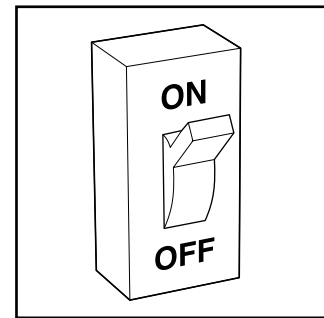

12

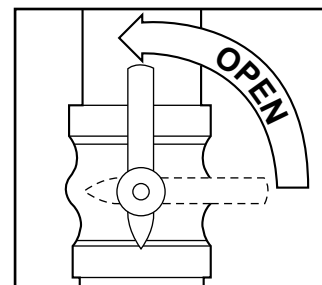

13

11. After 32 to 70 sec, the gas valve permits gas to flow to the main burners where it is ignited. Hot flames begin to warm the furnace's heat exchanger. After a time delay of approximately 25 (45 sec low-stage for 2-stage furnaces) sec, the furnace blower is switched on.

NOTE: If the main burners fail to ignite, the furnace control system will go through 3 more ignition cycles. Then, if burners fail to ignite, the system will

lockout. If lockout occurs, or the blower doesn't come on—shut down your furnace and call your dealer for service.

- Set your thermostat to the temperature that satisfies your comfort requirements. **SUGGESTION:** Setting the thermostat back a few degrees—and compensating for the difference with warmer clothing—can make a big difference in your fuel consumption on extremely cold days. The few degrees at the top of your thermostat “comfort level” are the most costly degrees to obtain.

When the room temperature drops below the temperature selected on the thermostat, the furnace will be switched on automatically. When the room temperature reaches the degree selected on the thermostat, the furnace will be switched off automatically.

Some thermostats have a “fan” mode with 2 selections: AUTO or ON. When set on AUTO, the furnace blower cycles on and off, controlled by the thermostat. In the ON position, the furnace blower runs continuously except for a 42-sec (62 sec low-stage for 2-stage furnaces) delay at the “call for heat.” This keeps the temperature level in your home more evenly balanced. It also continuously filters the indoor air.

SHUTTING DOWN YOUR FURNACE

Should you ever suspect a malfunction in your furnace, you will need to turn the furnace off. The following procedures must be followed:

- Set your room thermostat to the lowest temperature setting. (See Fig. 14.)
- Close the external manual gas valve. (See Fig. 6 on page 4.)
- Turn OFF the electrical supply to your furnace. (See Fig. 15.)
- Remove the outer door on your furnace. (See Fig. 8.)
- Turn the control switch on the gas valve to the OFF position. (See Fig. 9.)

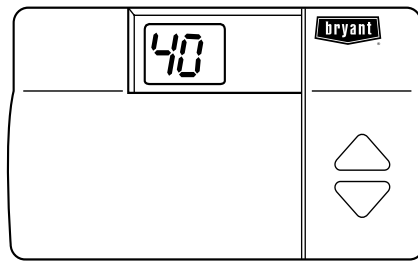

14

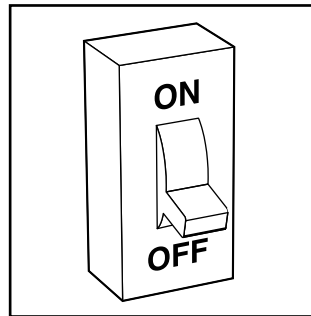

15

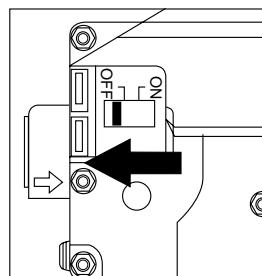
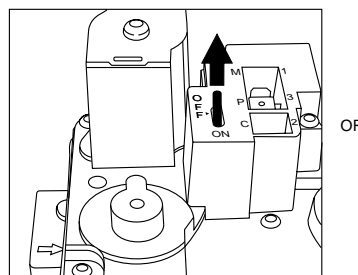

16

- Replace the outer door. (See Fig. 11.)
- If the furnace is being shut down because of a malfunction, call your dealer as soon as possible.

PERFORMING ROUTINE MAINTENANCE

With the proper maintenance and care, your furnace will operate economically and dependably. Basic maintenance,

which can easily be accomplished by someone who follows the directions, is found on this and the following pages. However, before beginning maintenance, follow these safety precautions:

⚠ WARNING

Turn off electrical power supply to your furnace before removing the access doors to service or perform maintenance. A failure to follow this warning could result in personal injury or death.

⚠ CAUTION

Although special care has been taken to minimize sharp edges, be extremely careful when handling parts or reaching into the furnace.

FILTERING OUT TROUBLE

A dirty filter will cause excessive stress on the furnace blower motor and can cause it to overheat and automatically shut down. The furnace filter should be checked every 3 or 4 weeks and cleaned if necessary.

If installed with factory specified disposable media filter, check or replace filter before each heating and cooling season. Replace disposable media filter at least once a year.

If your furnace filter needs replacing, be sure to use the same size and type of filter that was originally supplied.

⚠ CAUTION

Never operate your furnace without a filter in place. Doing so may damage the furnace blower motor. An accumulation of dust and lint on internal parts of your furnace can cause a loss of efficiency.

The air filter is located in the factory-supplied filter cabinet attached to the side or bottom of the blower cabinet.

If air filter has been installed in another location, contact your dealer for instructions. To inspect, clean, and/or replace the air filter(s), follow these steps:

- Turn off electrical supply to furnace (See Fig. 7.)

2. Remove filter cabinet door (See Fig. 18 and 19.)
3. Slide air filter out of filter cabinet. Keep dirty side up (if dirty) to avoid spilling dirt. See Fig. 20 and 21.)
4. Inspect the filter. If torn, replace it.

NOTE: If washable filter that was shipped with the furnace has been replaced by:

- a) Factory specified disposable media filter – Do not clean. If dirty, replace only with media filter having the same part number and size. Install with airflow direction arrow pointing towards blower.
 - b) Electronic air cleaner (EAC) – Refer to EAC owner’s Manual for maintenance information.
5. Wash filter (if dirty) in sink, bathtub, or outside with a garden hose. Always use cold tap water. A mild liquid detergent may be used if necessary. Spray water through filter in the opposite direction of airflow. Allow filter to dry.
 6. Reinstall clean air filter.
 7. Replace filter cabinet door. (See Fig. 22 and 23.)
 8. Turn on electrical supply to furnace (see Fig. 12.)

| AIR FILTER LOCATED IN FILTER CABINET: | | |
|---------------------------------------|-----------------------------------|-------------------------|
| FILTER CABINET HEIGHT (IN.) | FILTER SIZE (IN.) | FILTER TYPE |
| 16 | (1)16x25x1* or (1)16x25x4-5/16 | Cleanable Disposable |

* Factory provided with the furnace. Filters may be field modified by cutting filter material and support rods (3) in filters. Alternate sizes and additional filters may be ordered from your dealer.

⚠ CAUTION

Use care when cutting support rods in filters to protect against flying pieces and sharp rod ends. Wear safety glasses, gloves, and appropriate protective clothing. Failure to follow this caution could result in personal injury.

COMBUSTION AREA AND VENT SYSTEM

Inspect the combustion area and vent system before each heating season. An accumulation of dirt, soot, or rust can mean a loss of efficiency and improper performance. Buildups on the main burners can cause faulty firing. This “delayed ignition” is characterized by an alarmingly loud sound. If your furnace makes a loud noise when the main burners are ignited, shut down the furnace—call your servicing dealer.

Use your flashlight and follow these steps for inspecting the combustion area and vent system of your furnace:

1. Turn off the electrical supply to the furnace and remove the access door. (See Fig. 7 and 8.)
2. Carefully inspect the gas burner (see Fig. 17) for dirt, rust, or scale. Then inspect the elbow, flue connection area, and the vent pipe for rust.

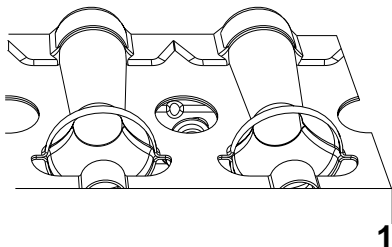

NOTE: If dirt, rust, soot, or scale accumulations are found, call your servicing dealer. **DO NOT OPERATE THE FURNACE.**

3. Inspect the vent pipe for a sag, holes, or a disconnection. A horizontal vent pipe must slope upward away from furnace. If rusty joints or seams, or signs of water leakages are found call your dealer for service.

⚠ WARNING

If holes are found—or if the vent pipe is obstructed or is not connected—toxic fumes can escape into your home. **DO NOT OPERATE YOUR FURNACE.** Call your dealer for service. A failure to follow this warning could result in personal injury or death.

4. Replace the access door and restore electrical power to the furnace. (See Fig. 12.)

5. Start the furnace and observe its operation. If possible, watch the burner flames. Are they burning bright blue? If not (or if you suspect some other malfunction), call your servicing dealer.

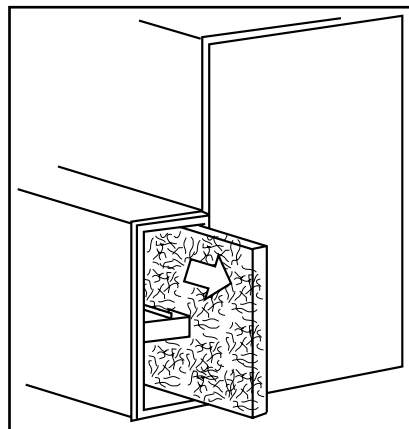
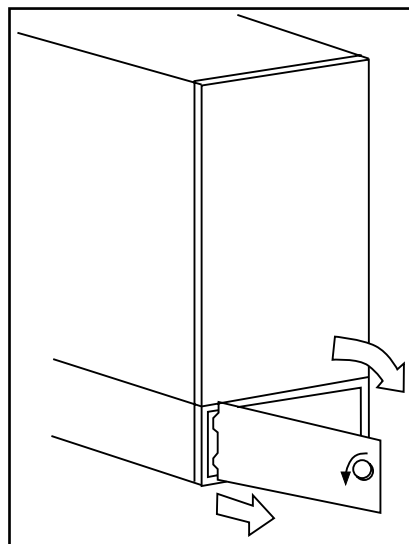
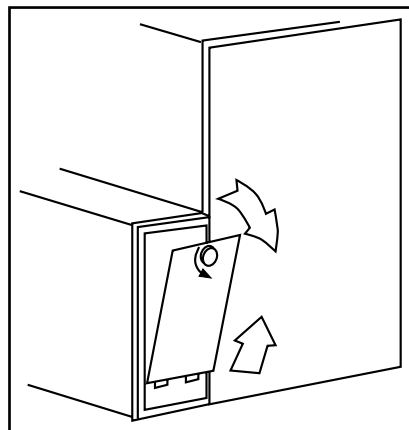

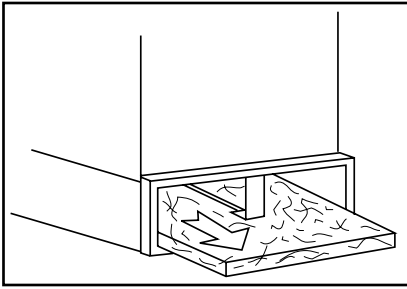

21

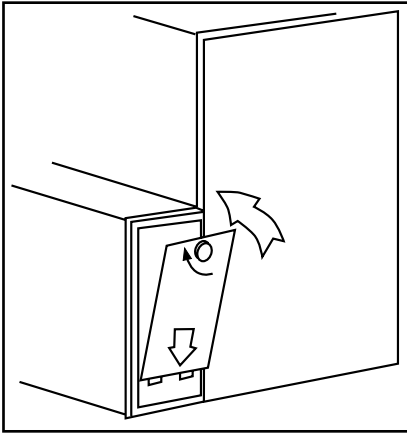

22

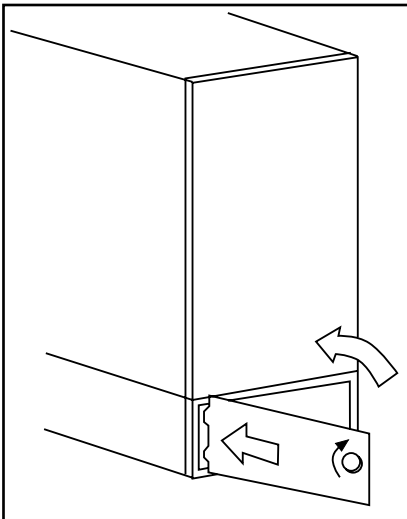

23

BEFORE YOU REQUEST A "SERVICE CALL"

BEFORE YOU CALL FOR SERVICE, CHECK FOR SEVERAL EASILY SOLVED PROBLEMS:

- Check for sufficient airflow. Check the air filter for dirt. Check for blocked return-air or supply-air grilles. Be sure they are open and unobstructed. If this

isn't the cause, call your servicing dealer.

If your furnace isn't operating at all, check the following list for easily solved problems:

- Is your thermostat set above room temperature? Is the HEAT mode selected?
- Is the electrical power supply switch ON? Is the blower access door firmly in place? Are any fuses blown? (There is a fuse on the furnace control board.) Has a circuit breaker tripped?
- Is the manual shutoff valve in the gas supply pipe leading to the furnace open? Does the lever point in the same direction that the pipe runs (open)? Or is it at right angles (closed)?

NOTE: Before proceeding with the next checks, turn OFF the electrical power supply to the furnace. Remove the access door.

- Is the switch on the gas valve turned to the ON position? If this or the preceding check shows an interruption in the gas supply, make sure the gas has not been shut off for safety reasons. If nothing else seems to be wrong, follow the startup procedures found on pages 4 and 5 of this booklet.

- If for some reason the vent is blocked, the blocked vent safeguard switch will shut off the furnace. (See page 2 for switch location.) The switch will automatically reset after the furnace cools off.

- Check the manual-reset limit switches located near the burners. If the furnace has experienced a high-temperature condition, due to inadequate combustion air, these switches will shut off the furnace. Reset the switches by pushing the button on the switch. If the switch trips a second time, turn off the furnace and call for service.

- If your furnace still fails to operate, call your servicing dealer for troubleshooting and repairs. Tell your dealer the model and serial numbers for your furnace. (You should have them recorded on page 8 of this booklet.) By knowing exactly which furnace you have, the dealer may be able to offer suggestions over the phone, or save valuable time through knowledgeable preparation for the service call.

REGULAR DEALER MAINTENANCE

In addition to the type of routine maintenance you might be willing to do, your furnace should be inspected regularly by a properly trained service technician. An annual inspection (or biennial inspection, at least) should include the following:

1. Inspection of all flue gas passages—including the burners, heat exchanger, inducer, elbow, and vent pipe.
2. Inspection of all combustion and ventilation air passages and openings.
3. Close check of all gas pipes leading to (and inside of) your furnace.
4. Inspection and cleaning of the blower motor and wheel.
5. Routine inspection and cleaning/replacement of the air filter.
6. Inspection of all supply- and return-air ducts for obstructions, air leaks, and insulation. Any problems found should be resolved at this time.
7. Inspection of furnace installation for proper support and any obvious deterioration of the furnace. The support must be sound and without sags, gaps, cracks, etc., around the furnace base so as to provide an air seal between the return-air duct and furnace.
8. A check for loose connections attaching individual components. Inspection of all electrical wiring and their connections.
9. Operational check of the furnace itself to determine working condition. Repair or adjustment should be made at this time.

Ask your servicing dealer for further details about an economical service contract that covers seasonal inspections.

INSTALLATION DATA

Date Installed _____

Dealer Name _____

Address _____

City _____

State/Province _____ Zip/Postal Code _____

Telephone _____

FURNACE

Product No. _____

Model No. _____

Serial No. _____

AIR CONDITIONER OR HEAT PUMP

OUTDOOR UNIT:

Product No. _____

Model No. _____

Serial No. _____

INDOOR COIL:

Product No. _____

Model No. _____

Serial No. _____

